

KRD tube terminals 16 - 1000 mm²

KRD240-16

- Material: Cu 99.95%, tin plated Cu/Sn.
- Inspection hole.
- For stranded (class 2) Cu conductors.

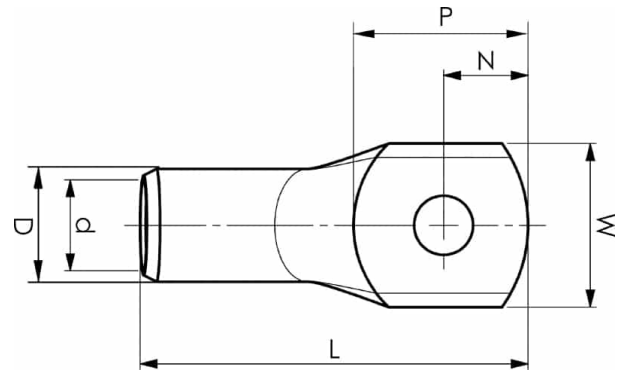

Example of marking KRD: 14 (neck) Elpress logotype 70 10 (palm)

14 = Die No. 70 = mm² 10 = palm hole for M10
Tube terminal type KRD for stranded (class 2) Cu
conductors, 240 mm², with an M16 hole in the palm.
Used with Elpress certified systems V1300 or V250.



Item number: **7301-102900**

EAN: **7393487006898**

W (mm): **39**

N (mm): **15**

N1 (mm): **16**

P (mm): **31**

f (mm): **1**

d (mm): **21**

D (mm): **27**

L (mm): **86**

t (mm) - palm thickness: **5.9**

s (mm) - strip length: **37**

Screw: **M16**

Inspection hole: **Yes**

AWG/MCM Cu: **450 MCM**

mm² Cu: **240**

ELPRESS