

KRF angled terminals 90°, 10 - 185 mm²

KRF120-16- 90GR

- Material: Cu 99.95%, tin plated Cu/Sn.
- Inspection hole.
- For stranded (class 2) and multi-stranded (class 5) Cu conductors, for multi-stranded Cu conductors contact crimping using the Dual system is recommended.
- UL-approved, DNV approved.

Example of marking KRF: 17 (neck) Elpress logo 70 10F (palm)

17 = Die No. 70 = mm² 10 = palm hole for M10 F = type KRF for stranded and flexible conductors.

Angled tube terminal 90° for multi-stranded (class 5) and stranded (class 2) Cu conductors (acc. to IEC 60228), 120 mm², with an M16 hole in the palm.

Used with Elpress certified systems V600, V1300, V250.

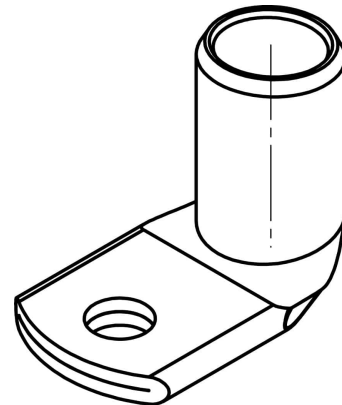
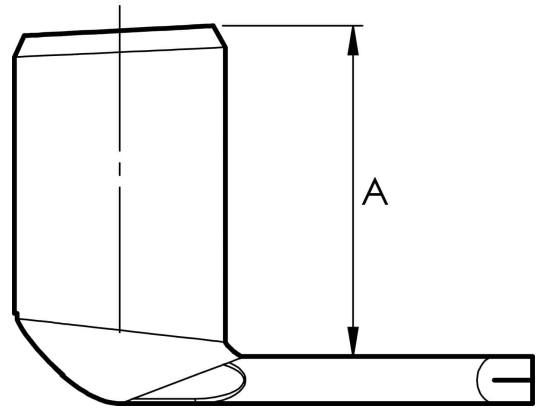
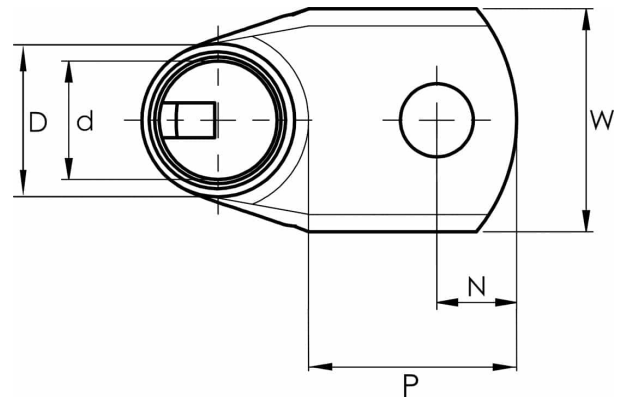

Item number: **7301-548100**

EAN: **7393487083912**

A (mm): **42**

W (mm): **32**

N (mm): **15.5**

N1 (mm): **20.5**

P (mm): **36**

d (mm): **17**

D (mm): **22**

t (mm) - palm thickness: **4.9**

s (mm) - strip length: **27**

Screw: **M16**

Angle (°): **90**

Inspection hole: **Yes**

AWG/MCM Cu: **4/0 AWG**

mm² Cu: **120**

ELPRESS