

Tube terminals 0.75 - 10 mm²

KR6-5

- Material: Cu 99.95%, tin plated Cu/Sn.
- For multi-stranded (class 5) and stranded (class 2) Cu conductors.
- UL approved.
- With inspection holes.

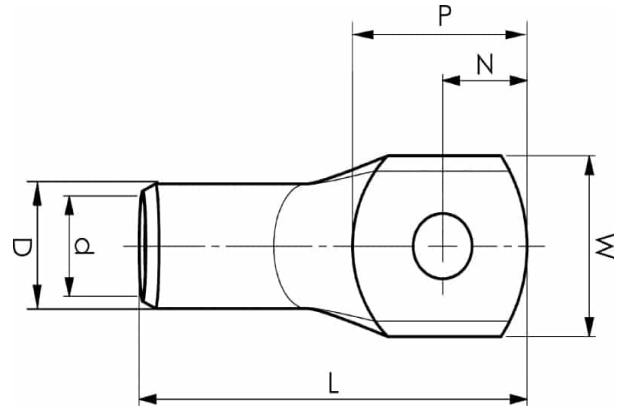

Examples of palm marking KR: 10-10

10 = mm² 10 = Palm hole for M10

Tube terminal for multi-stranded (class 5) and stranded (class 2) Cu-conductors (acc. to IEC 60228), 6 mm², with an M5 hole in the palm. Used with certified tool GWB4099 or ES2258.



Item number: **7301-011400**

EAN: **7393487005853**

W (mm): **9.5**

N (mm): **5**

N1 (mm): **6**

P (mm): **11**

d (mm): **4**

D (mm): **6**

L (mm): **22**

t (mm) - palm thickness: **1.7**

s (mm) - strip length: **8.5**

Screw: **M5**

Inspection hole: **Yes**

AWG/MCM Cu: **10 AWG**

mm² Cu: **6**