

DIN 46234 sheet metal terminals 10 - 185 mm²

B35-8R

- dimensions according to DIN 46234
- material: 99.9% Cu, tin plated (Cu/Sn)

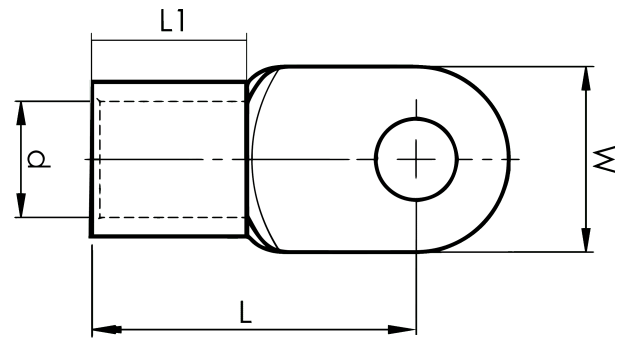

Sheet metal terminal for 35 mm² copper conductors with an M8 hole in the palm. Used with Elpress certified systems V600, V1300 or V250.



Item number: **7258-267200**

EAN: **7393487018624**

W (mm): **16**

d (mm): **9**

L1 (mm): **12**

L (mm): **26**

t (mm) - palm thickness: **1.6**

Screw: **M8**

Marking: **35**

AWG/MCM Cu: **2 AWG**

mm² Cu: **35**