

KRD tube terminals 16 - 1000 mm²

KRD240-20

- Material: Cu 99.95%, tin plated Cu/Sn.
- Inspection hole.
- For stranded (class 2) Cu conductors.

Example of marking KRD: 14 (neck) Elpress logotype 70 10 (palm)

14 = Die No. 70 = mm² 10 = palm hole for M10

Tube terminal type KRD for stranded (class 2) Cu
conductors, 240 mm², with an M20 hole in the palm.

Used with Elpress certified systems V1300 or V250.

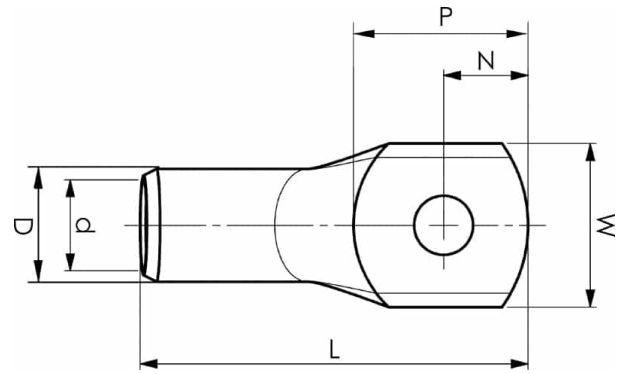

Item number: **7301-103000**

EAN: **7393487006904**

W (mm): **39**

N (mm): **19**

N1 (mm): **19**

P (mm): **38**

f (mm): **1**

d (mm): **21**

D (mm): **27**

L (mm): **93**

t (mm) - palm thickness: **5.9**

s (mm) - strip length: **37**

Screw: **M20**

Inspection hole: **Yes**

AWG/MCM Cu: **450 MCM**

mm² Cu: **240**