

KRF tube terminals (NS)

KRF35-8NS

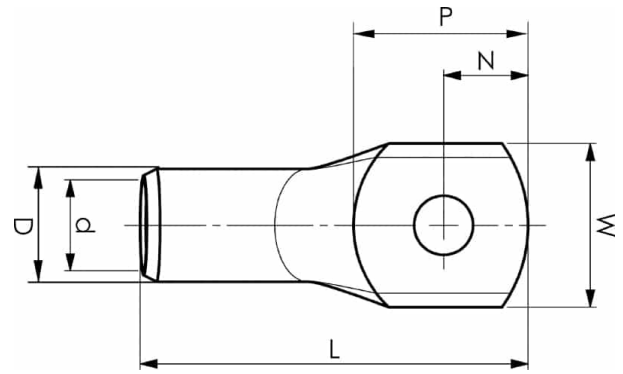

Item number: **7301-481900**

EAN: **7393487047396**

W (mm): **18**

N (mm): **10**

N1 (mm): **11**

P (mm): **21**

f (mm): **1**

d (mm): **9**

D (mm): **13**

L (mm): **47**

t (mm) - palm thickness: **3.9**

s (mm) - strip length: **16**

Screw: **M8**

AWG/MCM Cu: **2 AWG**

mm² Cu: **35**