

KRT tube terminals 10 - 500 mm²

KRT25-5

- Material: Cu 99.95%, tin plated Cu/Sn.
- Inspection hole.
- For stranded (class 2) Cu conductors.

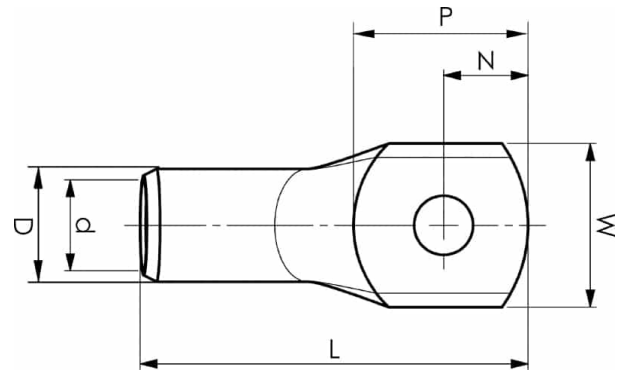

Example of marking KRT: 16 (neck) Elpress logotype 70 10 (palm)

16 = Die No. 70 = mm² 10 = palm hole for M10

Tube terminal type KRT for stranded (class 2) Cu conductors, 25 mm², with an M5 hole in the palm.

Used with Elpress certified systems V600, V1300 or V250.



UK
CA

Item number: **7301-275000**

EAN: **7393487018204**

W (mm): **14**

N (mm): **9**

N1 (mm): **12**

P (mm): **21**

d (mm): **7**

D (mm): **10**

L (mm): **43**

t (mm) - palm thickness: **2.9**

s (mm) - strip length: **17**

Screw: **M5**

Inspection hole: **Yes**

AWG/MCM Cu: **4 AWG**

mm² Cu: **25**

ELPRESS