

DIN 46234 sheet metal terminals 10 - 185 mm²

B50-12R

- dimensions according to DIN 46234
- material: 99.9% Cu, tin plated (Cu/Sn)

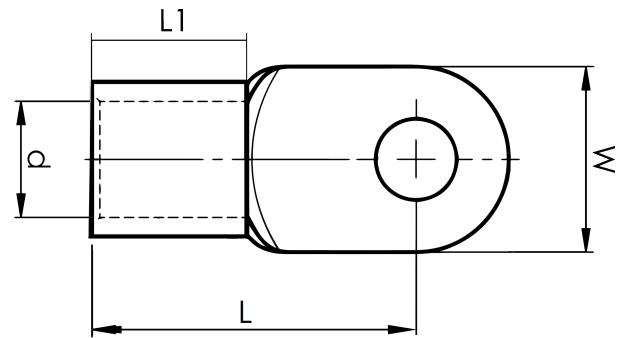

Sheet metal terminal for 50 mm² copper conductors with an M12 hole in the palm. Used with Elpress certified systems V600, V1300 or V250.



Item number: **7258-267900**

EAN: **7393487018693**

W (mm): **22**

d (mm): **11**

L1 (mm): **16**

L (mm): **36**

t (mm) - palm thickness: **1.8**

Screw: **M12**

Marking: **50**

AWG/MCM Cu: **1/0 AWG**

mm² Cu: **50**