

KRF16-6- 90GR



- Material: Cu 99.95%, tin plated Cu/Sn.
- Inspection hole.
- For stranded (class 2) and multi-stranded (class 5) Cu conductors, for multi-stranded Cu conductors contact crimping using the Dual system is recommended.
- DNV approved.

Example of marking KRF: 17 (neck) Elpress logo 70 10F (palm)

17 = Die No. 70 = mm² 10 = palm hole for M10 F = type KRF for stranded and flexible conductors.

Angled tube terminal 90° for multi-stranded (class 5) and stranded (class 2) Cu conductors (acc. to IEC 60228), 16 mm², with an M6 hole in the palm.

Used with Elpress certified systems V600, V1300, V250.

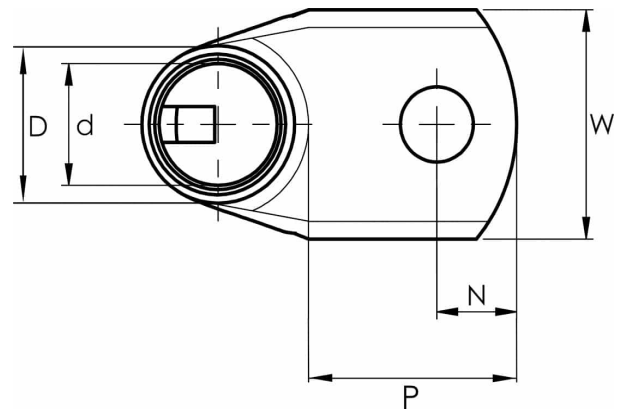

Item number: **7301-114700**

EAN: **7393487016330**

A (mm): **16.5**

W (mm): **13**

N (mm): **6.5**

N1 (mm): **11.5**

P (mm): **18**

d (mm): **6**

D (mm): **9**

t (mm) - palm thickness: **2.9**

s (mm) - strip length: **12**

Screw: **M6**

Angle (°): **90**

Inspection hole: **Yes**

AWG/MCM Cu: **6 AWG**

mm² Cu: **16**