

KRF95-10- 90GR



- Material: Cu 99.95%, tin plated Cu/Sn.
- Inspection hole.
- For stranded (class 2) and multi-stranded (class 5) Cu conductors, for multi-stranded Cu conductors contact crimping using the Dual system is recommended.
- UL-approved, DNV approved.

Example of marking KRF: 17 (neck) Elpress logo 70 10F (palm)

17 = Die No. 70 = mm² 10 = palm hole for M10 F = type KRF for stranded and flexible conductors.

Angled tube terminal 90° for multi-stranded (class 5) and stranded (class 2) Cu conductors (acc. to IEC 60228), 95 mm², with an M10 hole in the palm. Used with Elpress certified systems V600, V1300, V250.

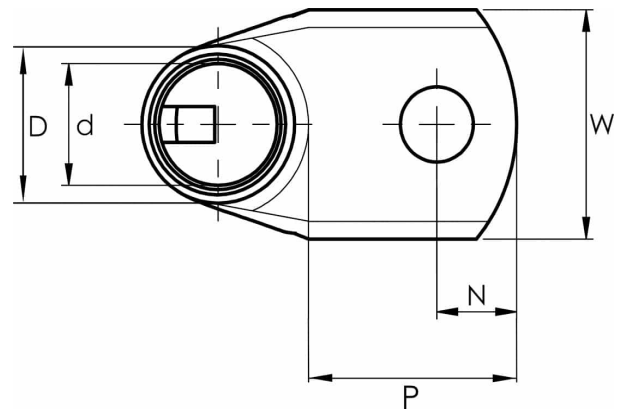

Item number: **7301-116800**
EAN: **7393487016484**

A (mm): **32.5**
W (mm): **28**
N (mm): **11.5**
N1 (mm): **18.5**
P (mm): **30**
d (mm): **15**
D (mm): **20**
t (mm) - palm thickness: **4.9**
s (mm) - strip length: **25**

Screw: **M10**
Angle (°): **90**
Inspection hole: **Yes**

AWG/MCM Cu: **3/0 AWG**
mm² Cu: **95**