

DIN 46234 sheet metal terminals 10 - 185 mm²

B16-12R

- dimensions according to DIN 46234
- material: 99.9% Cu, tin plated (Cu/Sn)

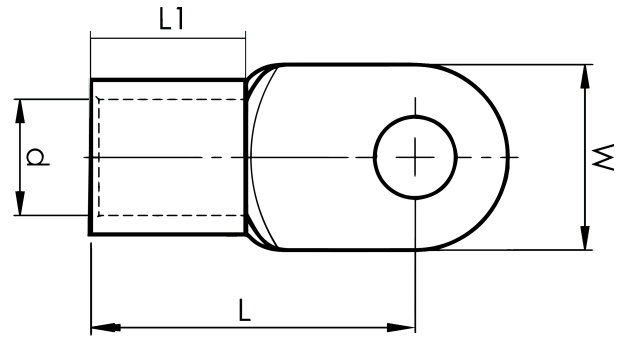

Sheet metal terminal for 16 mm² copper conductors with an M12 hole in the palm. Used with Elpress certified systems V600, V1300 or V250.



Item number: **7258-266400**
EAN: **7393487018549**

W (mm): **22**
d (mm): **5.8**
L1 (mm): **10**
L (mm): **26**
t (mm) - palm thickness: **1.2**

Screw: **M12**
Marking: **16**

AWG/MCM Cu: **6 AWG**
mm² Cu: **16**