

DIN 46234 sheet metal terminals 10 - 185 mm<sup>2</sup>

# B35-16R

- dimensions according to DIN 46234
- material: 99.9% Cu, tin plated (Cu/Sn)

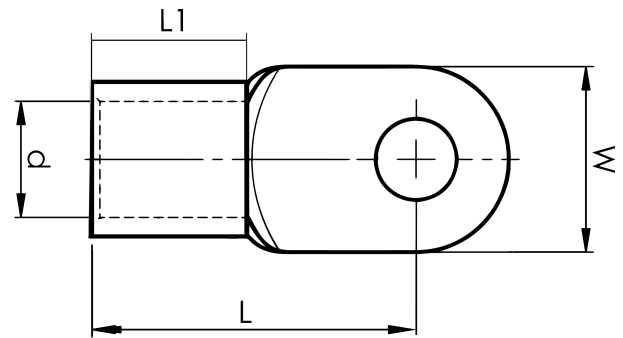

Sheet metal terminal for 35 mm<sup>2</sup> copper conductors with an M16 hole in the palm. Used with Elpress certified systems V600, V1300 or V250.



Item number: **7258-267500**

EAN: **7393487018655**

W (mm): **28**

d (mm): **9**

L1 (mm): **12**

L (mm): **36**

t (mm) - palm thickness: **1.6**

Screw: **M16**

Marking: **35**

AWG/MCM Cu: **2 AWG**

mm<sup>2</sup> Cu: **35**