

KRD tube terminals 16 - 1000 mm<sup>2</sup>

# KRD25-12

- Material: Cu 99.95%, tin plated Cu/Sn.
- Inspection hole.
- For stranded (class 2) Cu conductors.

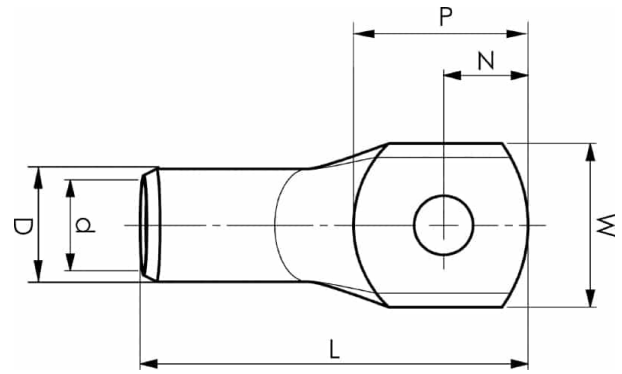

## Example of marking KRD: 14 (neck) Elpress logotype 70 10 (palm)

14 = Die No. 70 = mm<sup>2</sup> 10 = palm hole for M10

Tube terminal type KRD for stranded (class 2) Cu conductors, 25 mm<sup>2</sup>, with an M12 hole in the palm.

Used with Elpress certified systems V600, V1300 or V250.



Item number: **7301-104300**

EAN: **7393487006997**

W (mm): **22**

N (mm): **12**

N1 (mm): **13**

P (mm): **25**

f (mm): **1**

d (mm): **6.7**

D (mm): **9**

L (mm): **47**

t (mm) - palm thickness: **1.6**

s (mm) - strip length: **13**

Screw: **M12**

Inspection hole: **Yes**

AWG/MCM Cu: **4 AWG**

mm<sup>2</sup> Cu: **25**