

KRD tube terminals 16 - 1000 mm²

KRD35-16

- Material: Cu 99.95%, tin plated Cu/Sn.
- Inspection hole.
- For stranded (class 2) Cu conductors.

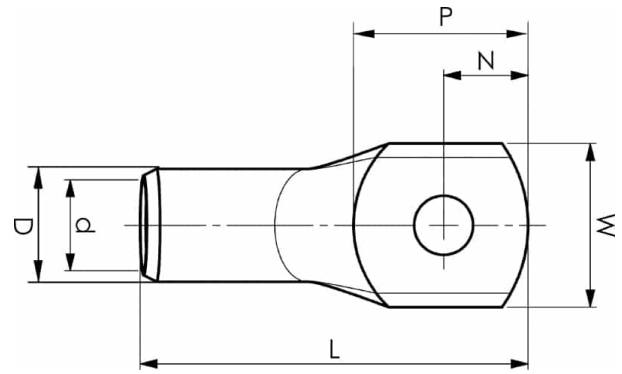

Example of marking KRD: 14 (neck) Elpress logotype 70 10 (palm)

14 = Die No. 70 = mm² 10 = palm hole for M10

Tube terminal type KRD for stranded (class 2) Cu
conductors, 35 mm², with an M16 hole in the palm.

Used with Elpress certified systems V600, V1300 or
V250.



Item number: **7301-499500**

EAN: **7393487089396**

W (mm): **25**

N (mm): **15**

N1 (mm): **18**

P (mm): **33**

f (mm): **1**

d (mm): **8**

D (mm): **11**

L (mm): **56**

t (mm) - palm thickness: **1.7**

s (mm) - strip length: **13**

Screw: **M16**

Inspection hole: **Yes**

AWG/MCM Cu: **2 AWG**

mm² Cu: **35**