

KRD tube terminals 16 - 1000 mm<sup>2</sup>

# KRD400-16

- Material: Cu 99.95%, tin plated Cu/Sn.
- Inspection hole.
- For stranded (class 2) Cu conductors.

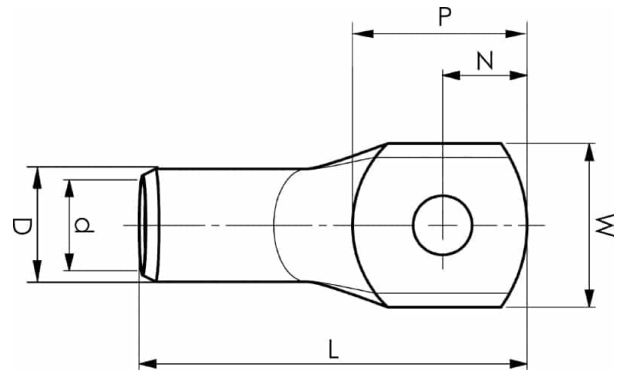

## Example of marking KRD: 14 (neck) Elpress logotype 70 10 (palm)

14 = Die No. 70 = mm<sup>2</sup> 10 = palm hole for M10

Tube terminal type KRD for stranded (class 2) Cu  
conductors, 400 mm<sup>2</sup>, with an M16 hole in the palm.

Used with Elpress certified systems V1300 or V250.



Item number: **7301-107400**

EAN: **7393487007048**

W (mm): **48**

N (mm): **22**

N1 (mm): **31**

P (mm): **53**

f (mm): **2**

d (mm): **26**

D (mm): **32**

L (mm): **116**

t (mm) - palm thickness: **5.8**

s (mm) - strip length: **44**

Screw: **M16**

Inspection hole: **Yes**

AWG/MCM Cu: **700 MCM**

mm<sup>2</sup> Cu: **400**