

KRD tube terminals 16 - 1000 mm²

KRD500-20

- Material: Cu 99.95%, tin plated Cu/Sn.
- Inspection hole.
- For stranded (class 2) Cu conductors.

Example of marking KRD: 14 (neck) Elpress logotype 70 10 (palm)

14 = Die No. 70 = mm² 10 = palm hole for M10
Tube terminal type KRD for stranded (class 2) Cu
conductors, 500 mm², with an M20 hole in the palm.
Used with Elpress certified systems V250 or V1470.

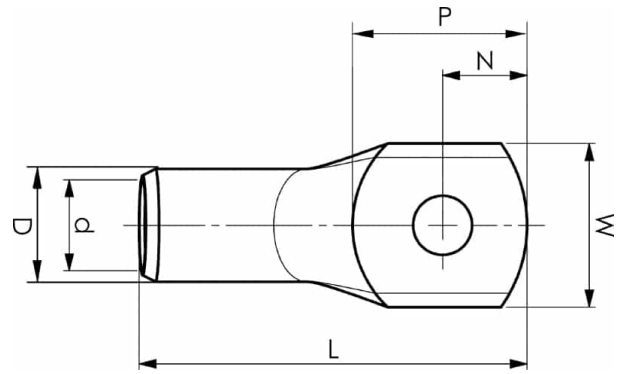

Item number: **7301-221200**

EAN: **7393487007086**

W (mm): **58**

N (mm): **25**

N1 (mm): **35**

P (mm): **60**

f (mm): **2.5**

d (mm): **31**

D (mm): **40**

L (mm): **150**

t (mm) - palm thickness: **8.8**

s (mm) - strip length: **70**

Screw: **M20**

Inspection hole: **Yes**

AWG/MCM Cu: **950 MCM**

mm² Cu: **500**