

KRF16-10

- Material: Cu 99.95%, tin plated Cu/Sn.
- With inspection holes.
- For stranded (class 2) and multi-stranded (class 5) Cu conductors, for multi-stranded Cu conductors contact crimping using the Dual system is recommended.
- UL-approved, DNV approved.



Example of marking KRF: 17 (neck) Elpress logotype 70 10F (palm)

17 = Die No. 70 = mm² 10 = palm hole for M10 F = type KRF for stranded and flexible conductors. Tube terminal for multi stranded (class 5) and stranded (class 2) Cu-conductors (acc. to IEC 60228), 16 mm², with an M10 hole in the palm. Used with Elpress certified systems V600, V1300 or V250.

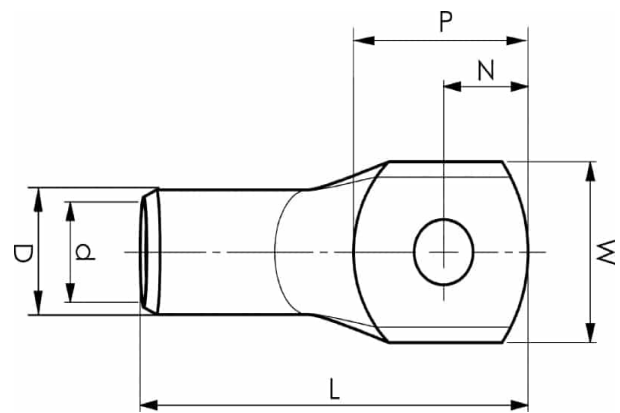

Item number: **7301-012300**
EAN: **7393487005945**

W (mm): **16**
N (mm): **10**
N1 (mm): **11**
P (mm): **21**
f (mm): **1.1**
d (mm): **6**
D (mm): **9**
L (mm): **38**
t (mm) - palm thickness: **2.3**
s (mm) - strip length: **11**

Screw: **M10**
Inspection hole: **Yes**

AWG/MCM Cu: **6 AWG**
mm² Cu: **16**