

KRF tube terminals with two holes

KRF95-12X2- 40

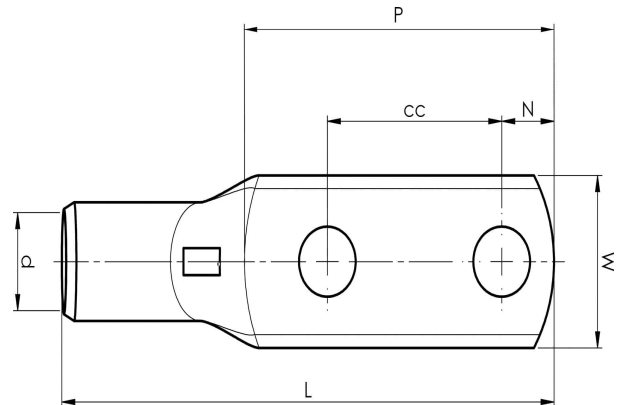

- Material: Cu 99.95%, tin plated Cu/Sn.
- Inspection hole.
- For stranded (class 2) and multi-stranded (class 5) Cu conductors, for multi-stranded Cu conductors contact crimping using the Dual system is recommended.
- UL-approved, DNV approved.

Example of marking KRF: 17 (neck) Elpress logotype 70 10F (palm)

17 = Die No. 70 = mm² 10 = palm hole for M10 F = type KRF for stranded and flexible conductors.
2 holed tube terminal for multi-stranded (class 5) and stranded (class 2) Cu-conductors (acc. to IEC 60228), 95 mm², with two M12 holes in the palm.
Used with Elpress certified systems V600, V1300 or V250.



Item number: **7301-240200**
EAN: **7393487007307**

W (mm): **29**
N (mm): **12**
N1 (mm): **18**
P (mm): **70**
cc (mm): **40**
f (mm): **1**
d (mm): **15**
D (mm): **20**
L (mm): **107**
t (mm) - palm thickness: **4.9**
s (mm) - strip length: **25**

Screw: **M12x2**
Inspection hole: **Yes**

AWG/MCM Cu: **3/0 AWG**
mm² Cu: **95**

ELPRESS