

Tube terminals 0.75 - 10 mm²

KR2,5-3

- Material: Cu 99.95%, tin plated Cu/Sn.
- For multi-stranded (class 5) and stranded (class 2) Cu conductors.
- UL approved.
- Without inspection hole.

Examples of palm marking KR: 10-10

10 = mm² 10 = Palm hole for M10

Tube terminal for multi-stranded (class 5) and stranded (class 2) Cu-conductors (acc. to IEC 60228), 2.5 mm², with an M3 hole in the palm. Used with certified tool DKB0325, DKB0760.

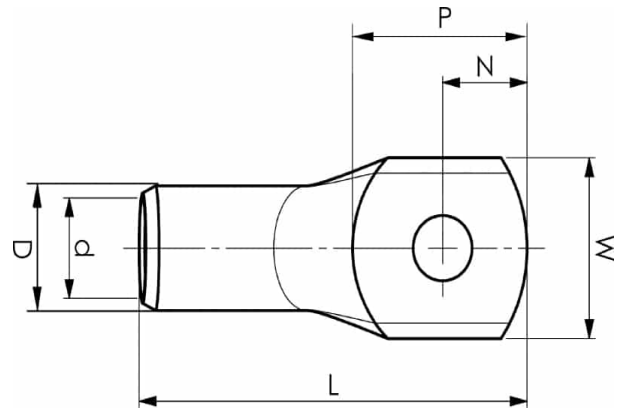

Item number: **7301-010500**

EAN: **7393487005778**

W (mm): **7.5**

N (mm): **3.5**

N1 (mm): **4.1**

P (mm): **7.6**

d (mm): **2.3**

D (mm): **4.2**

L (mm): **17**

t (mm) - palm thickness: **1.3**

s (mm) - strip length: **7**

Screw: **M3**

AWG/MCM Cu: **14 AWG**

mm² Cu: **2,5**