

Tab 0.5 - 2.5 mm²

B1003H

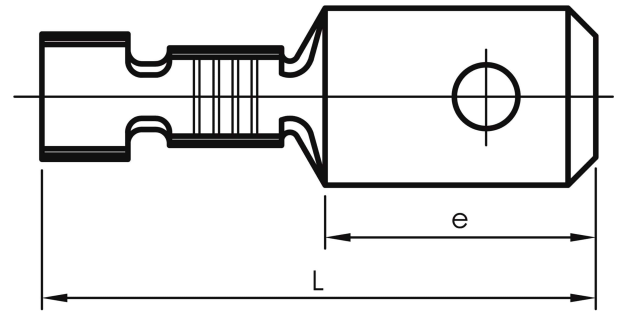

Item number: **7157-500100**

EAN: **7393487003316**

e (mm): **5.6**

L (mm): **12.7**

s (mm) - strip length: **7**

Tab Size: **2,8x0,8**

AWG/MCM Cu: **20 - 18 AWG**

mm² Cu: **0,5-1**